

Зип Общепит

vsezip.ru







+7(812)987-08-81



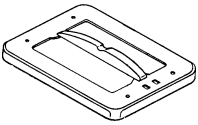
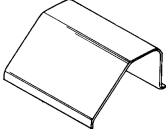

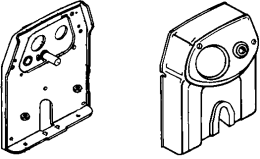
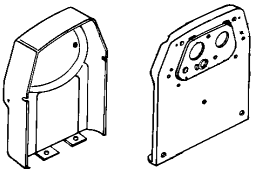

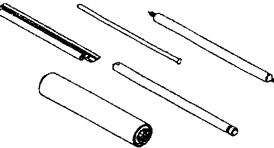

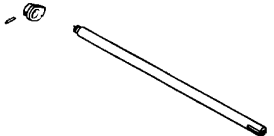
Listino Ricambi

Release 10.00 - Anno 2013

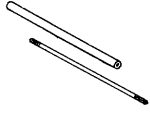

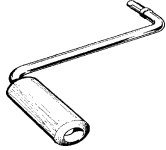
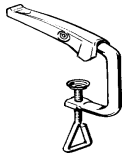
## Sfogliatrice Restaurant® Manuale R.220

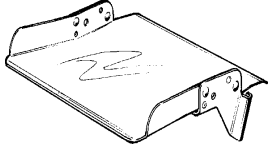
CODICE					
010					
DISEGNO	CODICE	DESCRIZIONE "KIT"	COMPONENTI	Q.TA'	PREZZO IN €
	<b>KR-A02</b>	KIT BASE	Piastra Base	1	<b>13,00</b>
	<b>KR-A03</b>	KIT SCIVOLATOIO	Scivolatoio	1	<b>5,50</b>
	<b>KR-A04</b>	KIT GREMBIALE	Grembiale Timbrato	2	<b>7,00</b>
	<b>KR-A05</b>	KIT RIVESTIMENTO LATERALE DX	Cuffia Destra	1	<b>16,00</b>
			Fianco Destro Con Perno	1	
	<b>KR-A06</b>	KIT RIVESTIMENTO LATERALE SX	Cuffia Sinistra	1	<b>13,00</b>
			Fianco Sinistro Con Perno	1	
	<b>KR-A07</b>	KIT INCASTELLATURA DX	Piastrina Destra Spallamento Rulli	1	<b>6,50</b>
			Leva A Squadra	1	
			Piastrina Destra Sopp. Raschiatore	1	
			Piastra Destra	1	
	<b>KR-A08</b>	KIT INCASTELLATURA SX	Scatola Ingranaggi	1	<b>8,50</b>
			Bocccola Eccentrica	1	
			Carter Sinistro	1	
			Piastrina Sinistra Spallamento Rulli	1	
			Leva A Squadra	1	
			Piastra Sinistra	1	
	<b>KR-A09</b>	KIT RULLI	Piastrina Sinistra Sopp. Raschiatore	1	<b>29,50</b>
			Rullo Liscio Completo	2	
			Raschiatore Liscio	2	
			Asse Fisso	1	
			Asta Raschiatore	2	
			Asse Oscillante Con Chiavetta	1	
	<b>KR-A20</b>	KIT RASCHIATORI	Raschiatore Liscio	2	<b>8,00</b>
	<b>KR-A10</b>	KIT REGOLAZIONE	Asse Porta Eccentrici Completo	1	<b>7,00</b>

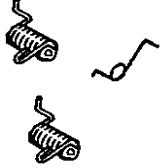
## Sfogliatrice Restaurant® Manuale R.220



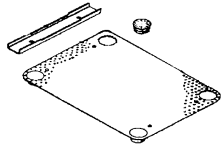
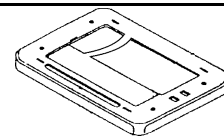
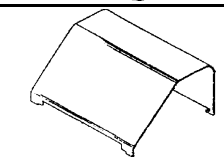
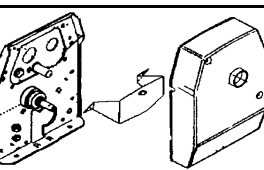
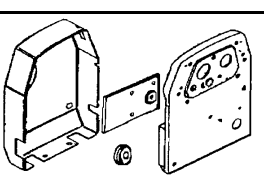
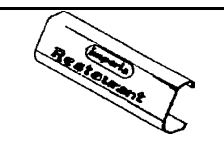
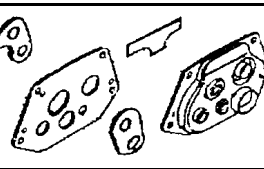
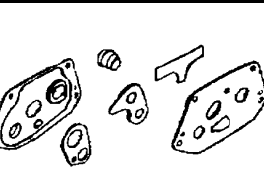

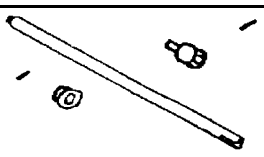
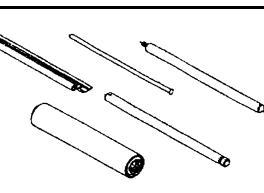

CODICE					
010					
DISEGNO	CODICE	DESCRIZIONE "KIT"	COMPONENTI	Q.TA'	PREZZO IN €
	KR-A11	KIT INGRANAGGI	Perno supporto Pignone	1	15,00
			Ingranaggio Intermedio	1	
			Ingranaggio Rulli Tirasfoglia	2	
			Pignone	1	
	KR-A12	KIT TIRANTI / TUBETTI	Tubetto Distanziale	4	4,50
			Tirante M6	7	
	KR-A13	KIT POMELLO	Pomello	1	8,00
			Fascia Graduata	1	
	KR-A14	KIT MANOVELLA	Manovella Sfogliatrice	1	6,00
	KR-A15	KIT MORSETTO CON LEVA	Morsetto	1	8,00
	KR-A16	KIT PIEDINI	Piedino Forato	4	6,50
	KR-A19	KIT TRAMOGGIA	Tramoggia	1	13,00
	KXR-A16	KIT MANOVELLA XR	Manovella Accessori	1	3,50
	KR-D01	KIT MOLLE	Molla Raschiatore Destra	2	2,50
			Molla Raschiatore Sinistra	2	
			Molla Ritorno Rulli	2	

## Macchina sfogliatrice Restaurant® R.M.N. 230v

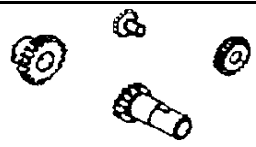
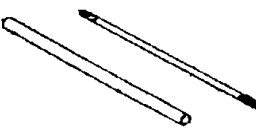
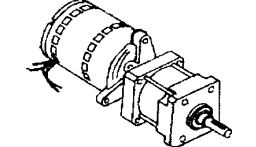
CODICE					
022					
DISEGNO	CODICE	DESCRIZIONE "KIT"	COMPONENTI	Q.TA'	PREZZO IN €
	KRMN-A01	KIT APPOGGI	Fondo Base	1	8,50
			Supporto Piedini	2	
			Piedino Forato	4	
	KRMN-A04	KIT BASE	Piastra Base	1	10,50
	KRMN-A03	KIT SCIVOLATOIO	Scivolatoio	1	5,50
	KRMN-A09	KIT RIVESTIMENTO LATERALE DX	Fianco Destro	1	21,00
			Staffa Sopperto Perno	1	
			Cuffia Destra	1	
			Boccola Sede Pignone	1	
	KRMN-A07	KIT RIVESTIMENTO LATERALE SX	Fianco Sinistro	1	19,00
			Coperchio Scatola Protezione	1	
			Gommino	2	
			Cuffia Sinistra	1	
	KR-A04	KIT GREMBIALE	Grembiale	1	7,00
	KRMN-A10	KIT INCASTELLATURA DX	Leva A Squadra	1	6,50
			Piastrina Destra Spallamento Rulli	1	
			Piastrina Destra Sopp. Raschiatore	1	
			Piastra Destra	1	
			Scatola Ingranaggi Completa	1	
	KRMN-A08	KIT INCASTELLATURA SX	Boccola Eccentrica	1	9,50
			Carter Sinistro	1	
			Leva A Squadra	1	
			Piastra Sinistra	1	
			Piastrina Sinistra Sopp. Raschiatore	1	
			Piastrina Sinistra Spallamento Rulli	1	
	KRMN-A06	KIT POMELLO	Pomello Completo	1	8,50
			Boccola Sede Pomello Forata	1	
			Spina Elastica 3 X 18	1	
	KRMN-A11	KIT REGOLAZIONE	Asse Porta Eccentrici Rmn	1	6,50
	KR-A09	KIT RULLI	Rullo Liscio R.220 Completo	2	29,50
			Raschiatore Liscio	2	
			Asse Fisso	1	
			Asta Raschiatore	2	
			Asse Oscilante Con Chiavetta	1	

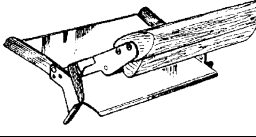

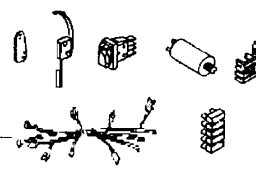
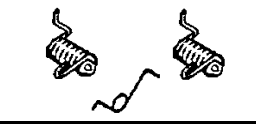

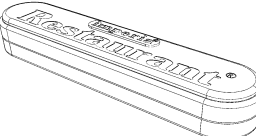
 Macchina sfogliatrice Restaurant® R.M.N. 230v





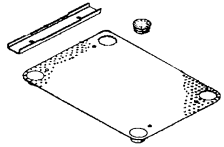
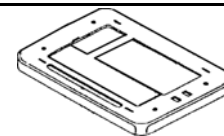
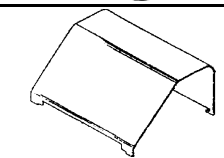
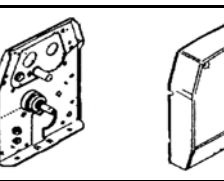
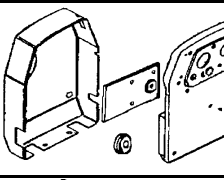
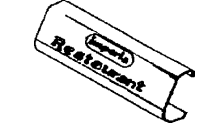
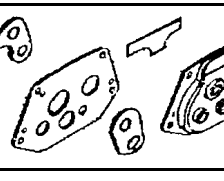
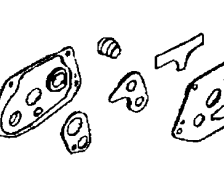
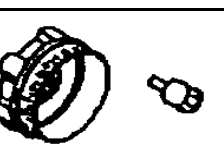
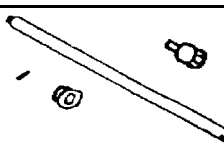
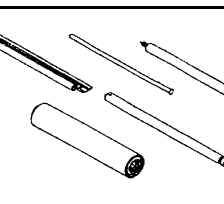

CODICE					
022					
DISEGNO	CODICE	DESCRIZIONE "KIT"	COMPONENTI	Q.TA'	PREZZO IN €
	KR-A20	KIT RASCHIATORI	Raschiatore Liscio	2	8,00
	KRMN-A14	KIT INGRANAGGI ACCIAIO	Perno Sopperto Pignone Ingranaggio Intermedio Ingranaggio Rulli Tira Sfoglia Pignone	1 1 2 1	19,00
	KR-A12	KIT TIRANTI / TUBETTI	Tubetto Distanziale Triante M6	4 6	4,50
	KRMN-A12	KIT MOTORIDUTTORE	Gruppo Motoriduttore Completo	1	304,50
	KRMN-A13	KIT INGRANAGGI PLASTICA	Ingr. Rotazione Pignone Ingranaggio Motore Ingranaggio Di Rinvio	1 1 1	5,50
	KRMN-A18	KIT TRAMOGGIA	Tramoggia Completa	1	29,50
	KRMN-A05	KIT ALIMENTAZIONE	Cavo Con Spina (Schuko) 230V Pressacavo	1 1	4,50
	KRMN-A02	KIT COMPONENTI ELETTRICI	Cavetto 0,75 X 70 Cavetto Terra 0,75 X 120 Interruttore Cappuccio Antispruzzo Condensatore Con Dado Sottomorsettiera Morsettiera Microinterruttore Con Leva Distanziale Microinterruttore	1 1 1 1 1 1 1 1	40,50
	KR-D01	KIT MOLLE	Molla Raschiatore Destra Molla Raschiatore Sinistra Molla Ritorno Rulli	2 2 2	2,50
	KRMN-E01	KIT VARIE / MINUTERIE	Piedino Forato Boccola Sede Pomello Gommino Chiavetta 4 X 5 X 9,5 Staffa Comando Micro Rondella Piana Ottone 32 X 17,5 X 0,5 Spina Elastica 3 X 18	4 1 2 2 1 1 1	3,00
	KRM-A10	KIT SCATOLA DI TRASMISSIONE	Scatola Trasmissione	1	29,00

## Macchina sfogliatrice Restaurant® Professional

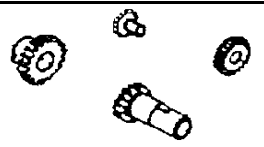
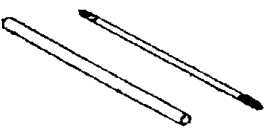
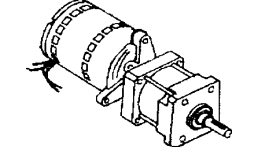

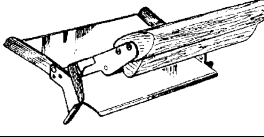
New

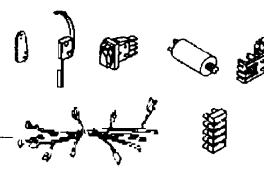
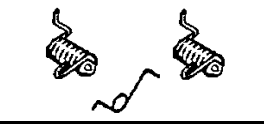
CODICE 032-034					
DISEGNO	CODICE	DESCRIZIONE "KIT"	COMPONENTI	Q.TA'	PREZZO IN €
	KRMN-A01	KIT APPOGGI	Fondo Base	1	8,50
			Supporto Piedini	2	
			Piedino Forato	4	
	KRMN-A20	KIT BASE PROFESSIONAL	Piastra Base	1	10,50
	KRMN-A03	KIT SCIVOLATOIO	Scivolatoio	1	5,50
	KRMN-A21	KIT RIVESTIMENTO DX PROFESSIONAL	Fianco Destro	1	21,00
			Cuffia Destra	1	
			Boccola Supporto Albero Motore	1	
			Boccola Sede Pignone	1	
	KRMN-A07	KIT RIVESTIMENTO LATERALE SX	Fianco Sinistro	1	19,00
			Coperchio Scatola Protezione	1	
			Gommino	2	
			Cuffia Sinistra	1	
	KR-A04	KIT GREMBIALE	Grembiale	1	7,00
	KRMN-A10	KIT INCASTELLATURA DX	Leva A Squadra	1	6,50
			Piastrina Destra Spallamento Rulli	1	
			Piastrina Destra Sopp. Raschiatore	1	
			Piastra Destra	1	
			Scatola Ingranaggi Completa	1	
	KRMN-A08	KIT INCASTELLATURA SX	Boccola Eccentrica	1	9,50
			Carter Sinistro	1	
			Leva A Squadra	1	
			Piastra Sinistra	1	
			Piastrina Sinistra Sopp. Raschiatore	1	
			Piastrina Sinistra Spallamento Rulli	1	
	KRMN-A06	KIT POMELLO	Pomello Completo	1	8,50
			Boccola Sede Pomello Forata	1	
			Spina Elastica 3 X 18	1	
	KRMN-A11	KIT REGOLAZIONE	Asse Porta Eccentrici Rmn	1	6,50
	KR-A09	KIT RULLI	Rullo Liscio R.220 Completo	2	29,50
			Raschiatore Liscio	2	
			Asse Fisso	1	
			Asta Raschiatore	2	
			Asse Oscilante Con Chiavetta	1	

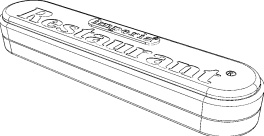
 Macchina sfogliatrice Restaurant® Professional



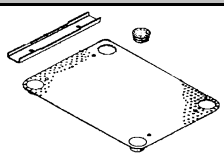
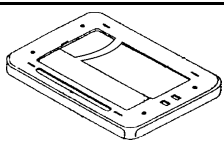
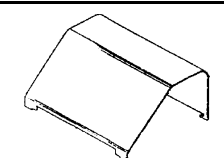
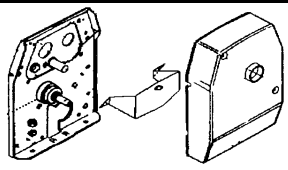
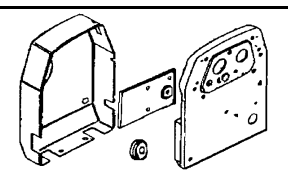
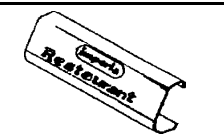
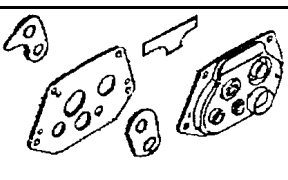
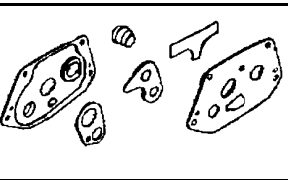

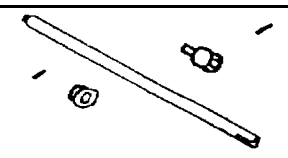
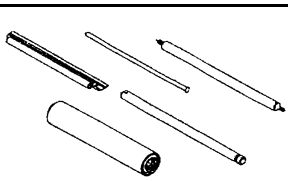



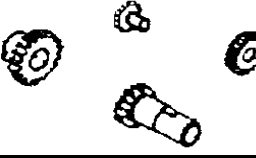

CODICE					
032-034					
DISEGNO	CODICE	DESCRIZIONE "KIT"	COMPONENTI	Q.TA'	PREZZO IN €
	KR-A20	KIT RASCHIATORI	Raschiatore Liscio	2	8,00
	KRMN-A14	KIT INGRANAGGI ACCIAIO	Perno Sopperto Pignone Ingranaggio Intermedio Ingranaggio Rulli Tira Sfoglia Pignone	1 1 2 1	19,00
	KR-A12	KIT TIRANTI / TUBETTI	Tubetto Distanziale Triante M6	4 6	4,50
	KRMN-A22	KIT MOTORIDUTTORE PROFESSIONAL	Gruppo Motoriduttore Completo	1	330,00
	KRMN-A23	KIT TRASMISSIONE PROFESSIONAL	Puleggia foro Ø17 Puleggia foro Ø10 Cinghia Dentata	1 1 1	12,50
	KRMN-A18	KIT TRAMOGGIA	Tramoggia Completa	1	29,50
	KRMN-A05	KIT ALIMENTAZIONE	Cavo Con Spina (Schuko) 230V Pressacavo	1 1	4,50
	KRMN-A24	KIT COMPONENTI ELETTRICI PROF.	Cavetto 0,75 X 70 Cavetto Terra 0,75 X 120 Interruttore Cappuccio Antispruzzo Condensatore Con Dado Sottomorsettiera Morsettiera Microinterruttore Con Leva Distanziale Microinterruttore	1 1 1 1 1 1 1 1	40,50
	KR-D01	KIT MOLLE	Molla Raschiatore Destra Molla Raschiatore Sinistra Molla Ritorno Rulli	2 2 2	2,50
	KRMN-E01	KIT VARIE / MINUTERIE	Piedino Forato Boccola Sede Pomello Gommino Chiavetta 4 X 5 X 9,5 Staffa Comando Micro Rondella Piana Ottone 32 X 17,5 X 0,5 Spina Elastica 3 X 18	4 1 2 2 1 1 1	3,00
	KRM-A10	KIT SCATOLA DI TRASMISSIONE	Scatola Trasmissione	1	29,00

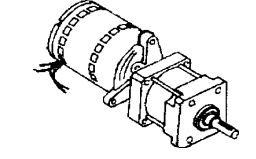
## Macchina sfogliatrice Restaurant® R.M.N. 120V

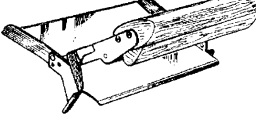
CODICE					
024					
DISEGNO	CODICE	DESCRIZIONE "KIT"	COMPONENTI	Q.TA'	PREZZO IN €
	KRMN-A01	KIT APPOGGI	Fondo Base	1	8,50
			Supporto Piedini	2	
			Piedino Forato	4	
	KRMN-A04	KIT BASE	Piastra Base	1	10,50
	KRMN-A03	KIT SCIVOLATOIO	Scivolatoio	1	5,50
	KRMN-A09	KIT RIVESTIMENTO LATERALE DX	Fianco Destro	1	21,00
			Staffa Sopperto Perno	1	
			Cuffia Destra	1	
			Boccola Sede Pignone	1	
	KRMN-A07	KIT RIVESTIMENTO LATERALE SX	Fianco Sinistro	1	19,00
			Coperchio Scatola Protezione	1	
			Gommino	2	
			Cuffia Sinistra	1	
	KR-A04	KIT GREMBIALE	Grembiale	1	7,00
	KRMN-A10	KIT INCASTELLATURA DX	Leva A Squadra	1	6,50
			Piastrina Destra Spallamento Rulli	1	
			Piastrina Destra Sopp. Raschiatore	1	
			Piastra Destra	1	
			Carter Destro	1	
			Boccola Sopperto Pignone	1	
	KRMN-A08	KIT INCASTELLATURA SX	Boccola Eccentrica	1	9,50
			Carter Sinistro	1	
			Leva A Squadra	1	
			Piastra Sinistra	1	
			Piastrina Sinistra Sopp. Raschiatore	1	
			Piastrina Sinistra Spallamento Rulli	1	
	KRMN-A06	KIT POMELLO	Pomello Completo	1	8,50
			Boccola Sede Pomello Forata	1	
			Spina Elastica 3 X 18	1	
	KRMN-A11	KIT REGOLAZIONE	Asse Porta Eccentrici	1	6,50
	KR-A09	KIT RULLI	Rullo Liscio Completo	2	29,50
			Raschiatore Liscio	2	
			Asse Fisso	1	
			Asta Raschiatore	2	
			Asse Oscillante Con Chiavetta	1	

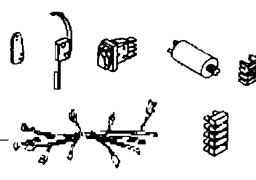

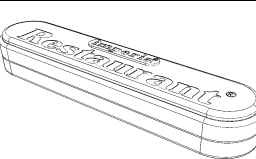

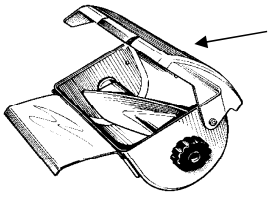
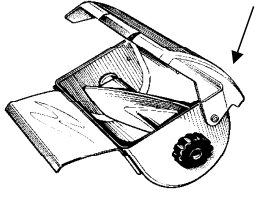
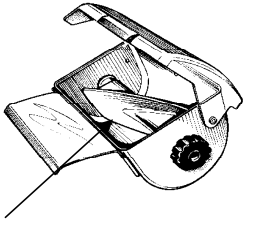
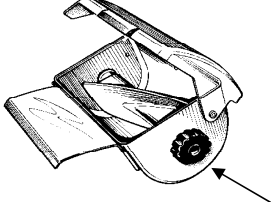
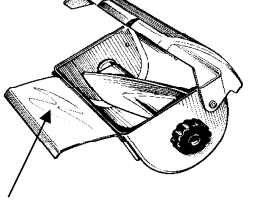

## Macchina sfogliatrice Restaurant® R.M.N. 120V

CODICE					
024					
DISEGNO	CODICE	DESCRIZIONE "KIT"	COMPONENTI	Q.TA'	PREZZO IN €
	KR-A20	KIT RASCHIATORI	Raschiatore Liscio	2	8,00
	KRMN-A14	KIT INGRANAGGI ACCIAIO	Perno Sopperto Pignone	1	19,00
			Ingranaggio Intermedio	1	
			Ingranaggio Rulli Tira Sfoglia	2	
			Pignone	1	
	KR-A12	KIT TIRANTI / TUBETTI	Tubetto Distanziale	4	4,50
			Triante M6	6	
	KRMN-A16	KIT MOTORIDUTTORE	Motore 120V - 60 Hz	1	315,00
			Controflangia	1	
			Riduttore Epicicloideale	1	
	KRMN-A13	KIT INGRANAGGI PLASTICA	Ingranaggio Rotazione Pignone	1	5,50
			Ingranaggio Motore	1	
			Ingranaggio Di Rinvio	1	
			Chiavetta 4 X 5 X 9,5	2	
	KRMN-A18	KIT TRAMOGGIA	Tramoggia Completa	1	29,50
	KRMN-A17	KIT ALIMENTAZIONE	Cavo Alimentazione (U.S.A.)	1	4,50
			Pressacavo	1	
	KRMN-A15	KIT COMPONENTI ELETTRICI	Cavetto 0,75 X 70	1	41,00
			Cavetto Terra 0,75 X 120	1	
			Interruttore	1	
			Cappuccio Antispruzzo	1	
			Condensatore Con Dado 120V	1	
			Sottomorsettiera	1	
			Morsettiera	1	
			Microinterruttore Con Leva	1	
			Distanziale Microinterruttore Rmn	1	
	KR-D01	KIT MOLLE	Molla Raschiatore Destra	2	2,50
			Molla Raschiatore Sinistra	2	
			Molla Ritorno Rulli	2	
	KRMN-E01	KIT VARIE / MINUTERIE	Piedino Forato	4	3,00
			Boccola Sede Pomello	1	
			Gommino	2	
			Chiavetta 4 X 5 X 9,5	2	
			Staffa Comando Micro	1	
			Spina Elastica 3 X 18	1	
	KRM-A10	KIT SCATOLA DI TRASMISSIONE	Scatola Trasmissione	1	29,00



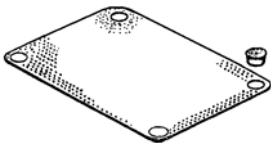

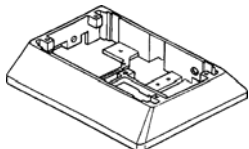
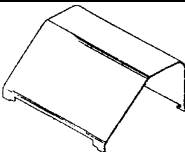
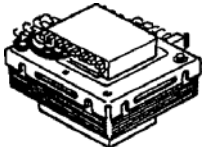
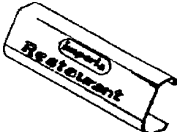
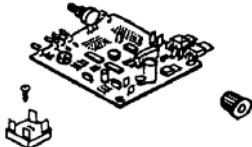

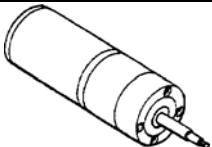
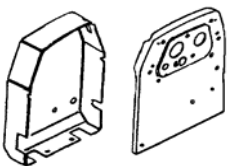

Зип Общепит  
Apparecchio impastatore Restaurant®

CODICE					
040					
DISEGNO	CODICE	DESCRIZIONE "KIT"	COMPONENTI	Q.TA'	PREZZO IN €
	<b>KIRM-A01</b>	KIT COPERCHIO	Coperchio Trasparente	1	<b>4,50</b>
	<b>KIRM-A02</b>	KIT TASSELLO	Tassello Bloccaggio Coperchio	1	<b>2,50</b>
			Vite Sopperto Tassello	1	
	<b>KIRM-A04</b>	KIT ELICA	Elica Impastatrice	1	<b>35,00</b>
	<b>KIRM-A05</b>	KIT MANOPOLE	Perno Sopperto Elica Destro	1	<b>3,00</b>
			Perno Sopperto Elica Sinistro	1	
	<b>KIRM-A06</b>	KIT RIPARO	Vite M4 X 6 T.1/2 Tonda T.Croce	3	<b>6,50</b>
			Grembiale Laterale	1	

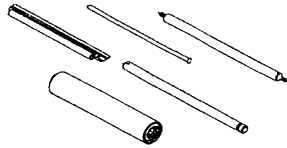

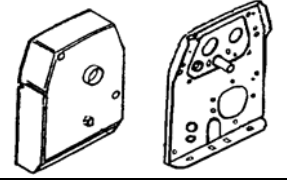
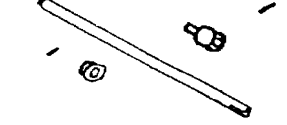
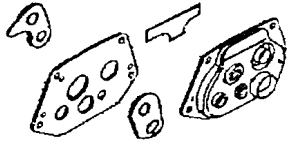
## Macchina sfogliatrice Restaurant® R.B.T. 230v

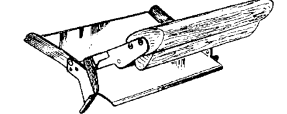
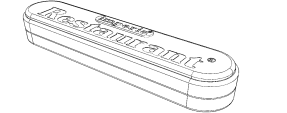
CODICE					
042					
DISEGNO	CODICE	DESCRIZIONE "KIT"	COMPONENTI	Q.TA'	PREZZO IN €
	<b>KRBT-A01</b>	KIT FONDO BASE COMPLETO	Fondo Base Piedino	1 4	<b>9,50</b>
	<b>KRBT-A02</b>	KIT CAVO ALIMENTAZIONE	Passacavo Stagno Ghiera Per Passacavo Cavo Alimentazione (Schuko)	1 1 1	<b>5,50</b>
	<b>KRBT-A03</b>	KIT PIASTRA BASE	Piastra Base	1	<b>42,00</b>
	<b>KRMN-A03</b>	KIT SCIVOLATOIO	Scivolatoio	1	<b>5,50</b>
	<b>KRBT-A04</b>	KIT TRASFORMATORE	Trasformatore Rbt 230V / 24V	1	<b>147,00</b>
	<b>KR-A04</b>	KIT GREMBIALE	Grembiale Restaurant	1	<b>7,00</b>
	<b>KRBT-A05</b>	KIT AZIONAMENTO	Gruppo Azionamento Ponte Di Raffreddamento Manopola Potenziometro	1 1 1	<b>173,50</b>
	<b>KRBT-A06</b>	KIT INTERRUOTTORE / CAVETTI	Cavetto Bianco Pvc L.80 Interruttore Unipolare Serie Spm Cavetto Blu 0,75 X 300 Capocorda Ad Occh. M6 Filo D. 0,75 Cavetto Nero 0,75 X 200 Cavetto Bianco 0,75 X 200 Distanziale Microinterruttore Cavetto Giallo / Verde Pvc 0,75 X 120 Microinterruttore Stagno	1 1 3 2 1 3 1 1 1	<b>37,00</b>
	<b>KRMN-A06</b>	KIT POMELLO	Pomello Completo Boccola Sede Pomello Forata Spina Elastica 3 X 18	1 1 1	<b>8,50</b>
	<b>KRBT-A07</b>	KIT MOTORIDUTTORE	Motoriduttore 24V.	1	<b>401,50</b>
	<b>KRBT-A08</b>	KIT RIVESTIMENTO LATERALE SX	Cuffia Sinistra Fianco Sinistro	1 1	<b>15,00</b>

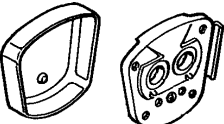
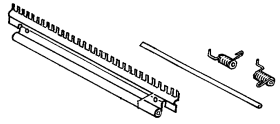
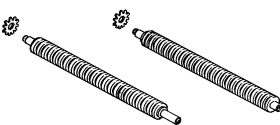
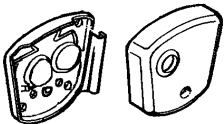
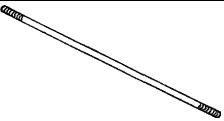

Зип Общепит  
Macchina sfogliatrice Restaurant® R.B.T. 230v

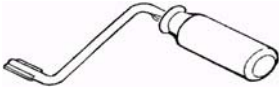
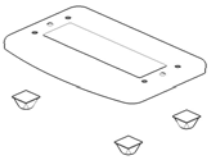
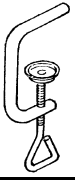
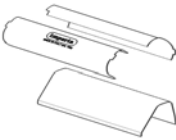
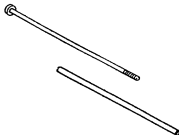
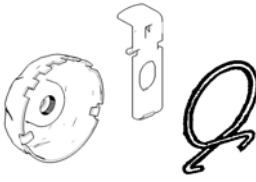
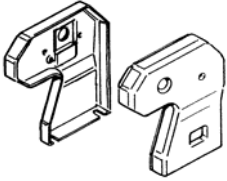
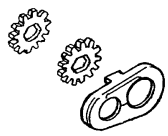
CODICE					
042					
DISEGNO	CODICE	DESCRIZIONE "KIT"	COMPONENTI	Q.TA'	PREZZO IN €
	<b>KRMN-A08</b>	KIT INCASTELLATURA SX	Boccola Eccentrica	1	<b>9,50</b>
			Carter Sinistro	1	
			Leva A Squadra	1	
			Piastrina Sinistra	1	
			Piastrina Sinistra Sopp. Raschiatore	1	
	<b>KRBT-A09</b>	KIT INGRANAGGI / CINGHIE	Ingranaggio Intermedio	1	<b>61,00</b>
			Ingranaggio Rulli Lisci	2	
			Perno Sopperto Pignone	1	
			Pignone	1	
			Puleggia Dentata (Z=23)	1	
			Puleggia Dentata (Z=52)	1	
	<b>KR-A09</b>	KIT RULLI	Rullo Liscio Completo	2	<b>29,50</b>
			Raschiatore Liscio	2	
			Asse Fisso	1	
			Asta Raschiatore	2	
			Asse Oscillante Con Chiavetta	1	
	<b>KR-A20</b>	KIT RASCHIATORI	Raschiatore Liscio	2	<b>8,00</b>
	<b>KRBT-A10</b>	KIT RIVESTIMENTO LATERALE DX	Cuffia Destra	1	<b>23,00</b>
			Fianco Destro	1	
	<b>KRMN-A11</b>	KIT REGOLAZIONE	Asse Porta Eccentrici	1	<b>6,50</b>
	<b>KRMN-A10</b>	KIT INCASTELLATURA DX	Leva A Squadra	1	<b>6,50</b>
			Piastrina Destra Spallamento Rulli	1	
			Piastrina Destra Sopp. Raschiatore	1	
			Piastra Destra	1	
			Carter Destro	1	
			Boccola Sopperto Pignone	1	
	<b>KR-A12</b>	KIT TIRANTI / TUBETTI	Tubetto Distanziale	4	<b>4,50</b>
			Tirante M6	6	
	<b>KRMN-A18</b>	KIT TRAMOGGIA	Tramoggia Completa	1	<b>29,50</b>
	<b>KRM-A10</b>	KIT SCATOLA DI TRASMISSIONE	Scatola Trasmissione	1	<b>29,00</b>
	<b>KR-D01</b>	KIT MOLLE	Molla Raschiatore Destra	2	<b>2,50</b>
			Molla Raschiatore Sinistra	2	
			Molla Ritorno Rulli	2	
	<b>KRBT-E01</b>	KIT VARIE / MINUTERIE	Piedino In Gomma	4	<b>5,50</b>
			Manopola Potenziometro	1	
			Boccola Sede Pomello	1	
			Staffa Comando Micro	1	
			Chiavetta 4 X 5 X 9,5	1	
			Spina Elastica 3 X 18	1	

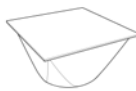
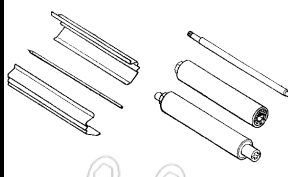

CODICE 060 ÷ 096		Apparecchio Simplex Restaurant®				
DISEGNO	CODICE	DESCRIZIONE "KIT"	COMPONENTI	Q.TA'	PREZZO IN €	
	<b>KXR-A01</b>	KIT GREMBIALI	Grembiale	2	<b>6,00</b>	
	<b>KXR-A04</b>	KIT RIVESTIMENTO LATERALE SX	Cuffia Sinistra Fianco Sinistro Boccola Sopporto Rulli	1 1 2	<b>4,00</b>	
	<b>KXR-A02</b>	KIT RASCHIATORI TAGLIO 1	Raschiatore Rigato Taglio 1 Asta Raschiatore Molla Destra Molla Sinistra	2 2 2 2	<b>4,00</b>	
	<b>KXR-A08</b>	KIT RASCHIATORI TAGLIO 2	Raschiatore Rigato Taglio 2 Asta Raschiatore Molla Destra Molla Sinistra	2 2 2 2	<b>4,00</b>	
	<b>KXR-A10</b>	KIT RASCHIATORI TAGLIO 3	Raschiatore Rigato Taglio 3 Asta Raschiatore Molla Destra Molla Sinistra	2 2 2 2	<b>4,00</b>	
	<b>KXR-A12</b>	KIT RASCHIATORI TAGLIO 4	Raschiatore Rigato Taglio 4 Maschio Raschiatore Rigato Taglio 4 Femmina Asta Raschiatore Molla Destra Molla Sinistra	1 1 2 2 2	<b>4,00</b>	
	<b>KXR-A14</b>	KIT RASCHIATORI TAGLIO 5	Raschiatore Rigato Taglio 5 Asta Raschiatore Molla Destra Molla Sinistra	2 2 2 2	<b>4,00</b>	
	<b>KXR-A20</b>	KIT RASCHIATORI TAGLIO SPAGHETTI	Raschiatore Rigato Taglio 2 Asta Raschiatore Molla Destra Molla Sinistra	2 2 2 2	<b>4,00</b>	
	<b>KXR-A18</b>	KIT RASCHIATORI TAGLIO REGINETTE	Raschiatore Rigato Taglio 12 Raschiatore Liscio Asta Raschiatore Molla Destra Molla Sinistra	1 1 2 2 2	<b>4,00</b>	
		<b>KXR-A07</b>	KIT RULLI TAGLIO 1	Rullo Conduttore Tg.1 Rullo Condotta Tg.1 Ingranaggio	1 1 2	<b>16,50</b>
		<b>KXR-A09</b>	KIT RULLI TAGLIO 2	Rullo Conduttore Tg.2 Rullo Condotta Tg.2 Ingranaggio	1 1 2	<b>16,50</b>
		<b>KXR-A11</b>	KIT RULLI TAGLIO 3	Rullo Conduttore Tg.3 Rullo Condotta Tg.3 Ingranaggio	1 1 2	<b>16,50</b>
		<b>KXR-A13</b>	KIT RULLI TAGLIO 4	Rullo Conduttore Tg.4 Rullo Condotta Tg.4 Ingranaggio	1 1 2	<b>16,50</b>
		<b>KXR-A15</b>	KIT RULLI TAGLIO 5	Rullo Conduttore Tg.5 Rullo Condotta Tg.5 Ingranaggio	1 1 2	<b>16,50</b>
<b>KXR-A17</b>		KIT RULLI TAGLIO SPAGHETTI	Rullo Conduttore Tg.Spaghetti Rullo Condotta Tg.Spaghetti Ingranaggio	1 1 2	<b>16,50</b>	
<b>KXR-A19</b>		KIT RULLI TAGLIO REGINETTE	Rullo Liscio Di Contrasto Xr Albero Esagonale Ch.14 Tubetto Distanziale 18 X 10,06 Rondella Zigrinata 22,5 X 5 Ingranaggio	1 1 14 15 2	<b>16,50</b>	
	<b>KXR-A03</b>	KIT RIVESTIMENTO LATERALE DX	Cuffia Destra Fianco Destro Boccola Sopporto Rulli	1 1 2	<b>4,00</b>	
	<b>KXR-A06</b>	KIT TIRANTI	Tirante M6	4	<b>2,50</b>	

CODICE					
100 / 162					
DISEGNO	CODICE	DESCRIZIONE "KIT"	COMPONENTI	Q.TA'	PREZZO IN €
	KSSP-A01	KIT MANOVELLA SS	Manovella Con Tappino Cromato	1	3,00
	KSSI-A01	KIT BASE	Base	1	4,00
			Piedino Autoadesivo In Gomma	4	
	KSSP-A03	KIT MORSETTO	Morsetto	1	3,00
	KSSI-A02	KIT SCIVOLATOIO / GREMBIALI	Grembiale Anteriore	1	3,50
			Grembiale Posteriore	1	
			Scivolatoio	1	
	KSSP-A05	KIT TIRANTI / TUBETTI	Tubetto Distanziale	3	2,50
			Tirante 5,25 X 157	3	
	KSSI-A03	KIT POMELO CON TAPPINO	Pomello Regolatore	1	2,50
			Molla Pomello	1	
			Tappino Cromato	1	
			Leva Pomello	1	
	KSSI-A04	KIT CUFFIE	Cuffia Sinistra	1	3,50
			Cuffia Destra	1	
	KSSP-A08	KIT CARTERINO / INGRANAGGI	Carterino	1	2,50
			Ingranaggio Rulli Lisci	2	
	KSSI-A05	KIT RASCHIATORI	Raschiatore Liscio Fisso In Resina Acetalica	3	2,00
			Raschiatore Liscio Oscill. In Resina Acetalica	3	
	KSP5-A23	KIT PIEDINI	Piedino Autoadesivo	4	2,50
	KSSP-A09	KIT RULLI LISCI	Asta Sopperto Raschiatore	2	5,50
			Asse Eccentrico	1	
			Rullo Liscio Sp Fisso	1	
			Rullo Liscio Sp Oscillante	1	
			Rondella Di Rasamento	2	
			Raschiatore Liscio Fisso In Resina Acetalica	1	

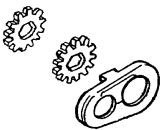
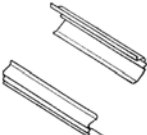
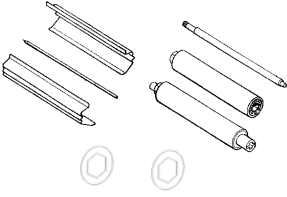
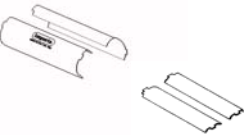
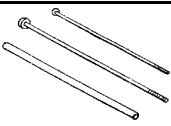
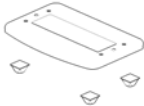
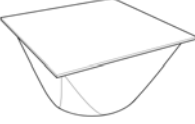
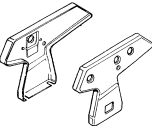
CODICE					
100 / 162		Sfogliatrice imperia® iPastà			
DISEGNO	CODICE	DESCRIZIONE "KIT"	COMPONENTI	Q.TA'	PREZZO IN €
			Raschiatore Liscio Oscill. In Resina Acetalica	1	

CODICE					
190 (ex 180)					
DISEGNO	CODICE	DESCRIZIONE KIT	COMPONENTI	Q.TA'	PREZZO IN €
	KSSP-A01	KIT MANOVELLA SSI	Manovella Con Tappino Cromato	1	3,00
	KSSP-A03	KIT MORSETTO	Morsetto	1	3,00
	KSSI-A03	KIT POMELLO ARROTONDATO	Pomello Regolatore	1	2,50
			Molla Pomello	1	
			Tappino Cromato	1	
			Leva Pomello	1	
	KSSP-A08	KIT CARTERINO / INGRANAGGI	Carterino	1	2,50
			Ingranaggio Rulli Lisci	2	
	KSSI-A05	KIT RASCHIATORI	Raschiatore Liscio Fisso In Resina Acetalica	3	2,00
			Raschiatore Liscio Oscill. In Resina Acetalica	3	
	KSSP-A09	KIT RULLI LISCI	Asta Sopperto Raschiatore	2	5,50
			Asse Eccentrico In Alluminio	1	
			Rullo Liscio Sp Fisso	1	
			Rullo Liscio Sp Oscillante	1	
			Rondella Di Rasamento	2	
			Raschiatore Liscio Fisso In Resina Acetalica	1	
	KTEI-A01	KIT GREMBIALI TE	Grembiale Anteriore Timbrato Titania	1	3,00
			Grembiale Centrale Con Taglio	1	
			Grembiale Duplex Centrale	1	
			Grembiale Posteriore	1	
	KTE-A02	KIT TIRANTI / TUBETTO	Tubetto Distanziale	1	2,50
			Tirante M6	3	
			Tirante M4	1	
	KSSI-A01	KIT BASE	Base	1	4,00
			Piedino Autoadesivo In Gomma	4	
	KSP5-A23	KIT PIEDINI	Piedino Autoadesivo	4	2,50
	KTE-A04	KIT CUFFIE	Cuffia Sinistra	1	4,00
			Cuffia Destra	1	

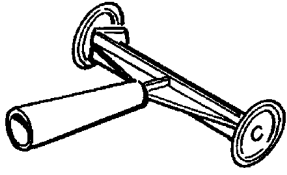
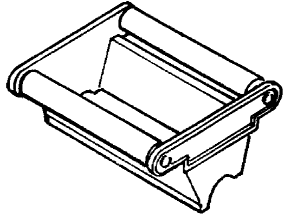







CODICE					
400					
DISEGNO	CODICE	DESCRIZIONE "KIT"	COMPONENTI	Q.TA'	PREZZO IN €
	KRS-A01	KIT TAGLIERINA RAVIOLATORE	Corpo	1	3,00
			Perno	1	
			Disco	2	
	KRS-A05	KIT TRAMOGGIA RAVIOLATORE	Tramoggia In Plastica	1	3,00
			Rullo In Legno	2	
	KRS-A08	KIT PROLUNGHE	Prolunga Raviolatore	5	3,00

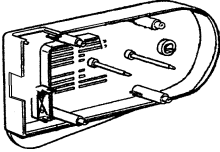
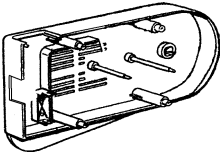

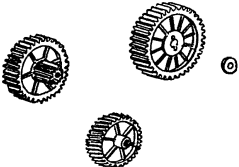
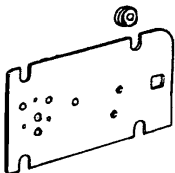
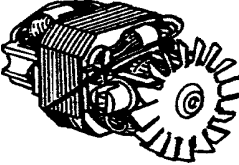
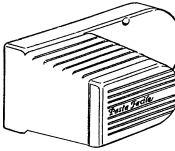
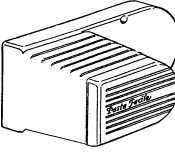
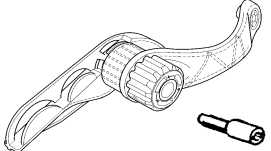
CODICE		Sparabiscotti Imperia Cookies®			New
580					
DISEGNO	CODICE	DESCRIZIONE "KIT"	COMPONENTI	Q.TA'	PREZZO IN €
	KSBI-A01	KIT DISCHETTI / BECCUCCI	Dischetto Trafila	14	3,50
			Beccuccio Decoratore	4	

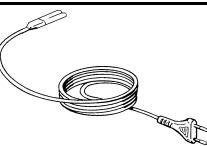
CODICE 600 / 610		3ip Общепит Motoriduttore PastaFacile® 230V			
DISEGNO	CODICE	DESCRIZIONE "KIT"	COMPONENTI	Q.TA'	PREZZO IN €
	KPF-A10	KIT RIVESTIMENTO INFERIORE METALLIZZATO	Fondello Metallizzato	1	4,00
			Albero Zigrinato	2	
	KPF-A11	KIT RIVESTIMENTO INFERIORE BEIGE	Fondello Beige	1	3,00
			Albero Zigrinato	2	
	KPF-A02	KIT TRASCINAMENTO	Albero Trascinamento	1	2,50
			Boccola	2	
			Spina 3 X 16	1	
	KPF-A03	KIT INGRANAGGI	Ingranaggio Albero Motore	1	4,50
			Ingranaggio Centrale	1	
			Ingranaggio Trascinamento	1	
			Rondella Bakelite 20 X 8,1	1	
	KPF-A12	KIT PIASTRA IN PLASTICA	Piastra Portaingranaggi Plastica	1	3,00
			Gommino Antivibrazione	4	
	KPF-A05	KIT MOTORE	Motore 230V	1	22,50
			Ventola In Plastica	1	
	KPF-A13	KIT RIVESTIMENTO SUPERIORE METALLIZZATO	Involucro Metallizzato	1	5,00
	KPF-A14	KIT RIVESTIMENTO SUPERIORE BEIGE	Involucro Beige	1	4,00
	KPF-A15	KIT GUIDA MOTORIDUTTORE BLU TRASPARENTE	Guida Universale	1	5,50
			Prolunga Per Raviolatore	1	
	KPF-A16	KIT COMPONENTI ELETTRICI	Interruttore I-0-II Instabile Nero	1	3,50
			Cavetto L=80	2	
			Connettore Iec Bipolare A Pannello	1	
			Condensatore	1	
	KPF-A17	KIT CAVO ALIMENTAZIONE	Cavo Alimentazione Con Connettore	1	2,50

Зип Общепит  
 Motoriduttore PastaFacile® 120V

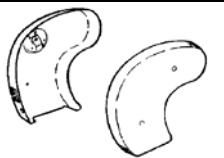
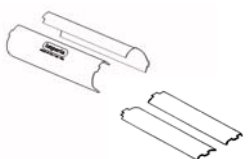
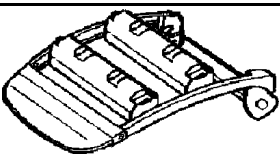
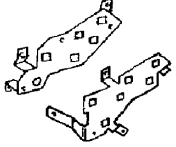
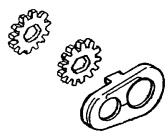
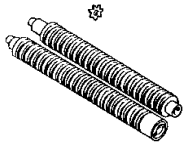
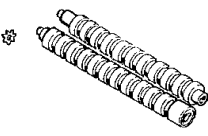
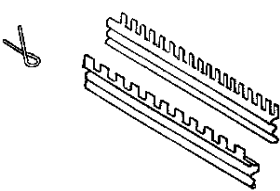
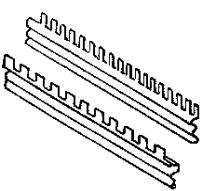
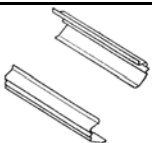
CODICE					
620 / 630					
DISEGNO	CODICE	DESCRIZIONE KIT	COMPONENTI	Q.TA'	PREZZO IN €
	KPF-A10	KIT RIVESTIMENTO INFERIORE METALLIZZATO	Fondello Metallizzato	1	4,00
			Albero Zigrinato	2	
	KPF-A11	KIT RIVESTIMENTO INFERIORE BEIGE	Fondello Beige	1	3,00
			Albero Zigrinato	2	
	KPF-A02	KIT TRASCINAMENTO	Albero Trascinamento	1	2,50
			Boccola	2	
			Spina 3 X 16	1	
	KPF-A03	KIT INGRANAGGI	Ingranaggio Albero Motore	1	4,50
			Ingranaggio Centrale	1	
			Ingranaggio Trascinamento	1	
			Rondella Bakelite 20 X 8,1	1	
	KPF-A04	KIT PIASTRA IN METALLO	Piastra Portaingranaggi In Metallo	1	3,00
			Gommino Antivibrazione	4	
	KPF-A01	KIT MOTORE	Motore 120V - 80W con Ventola	1	22,50
	KPF-A13	KIT RIVESTIMENTO SUPERIORE METALLIZZATO	Involucro Metallizzato	1	5,00
	KPF-A14	KIT RIVESTIMENTO SUPERIORE BEIGE	Involucro Beige	1	4,00
	KPF-A15	KIT GUIDA MOTORIDUTTORE BLU TRASPARENTE	Guida Universale	1	5,50
			Prolunga Per Raviolatore	1	
	KPF-A16	KIT COMPONENTI ELETTRICI	Interruttore I-0-II Instabile Nero	1	3,00
			Cavetto L=80 Omologato UL	2	
			Connettore IEC Bipolare A Pannello	1	
	KPF-A17	KIT CAVO ALIMENTAZIONE	Cavo Alimentazione Con Connettore Polarizzato	1	2,50

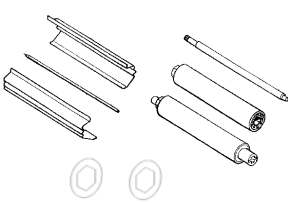
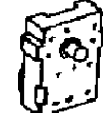
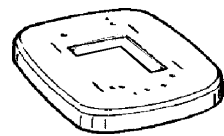
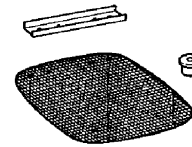
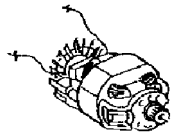
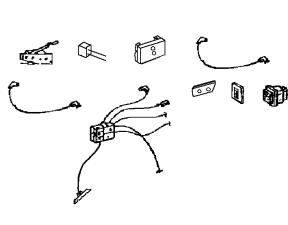
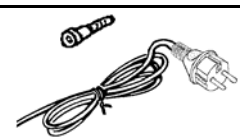

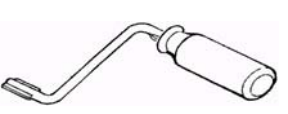

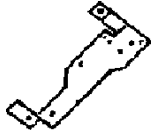
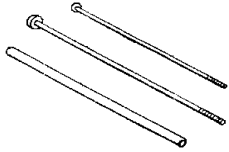

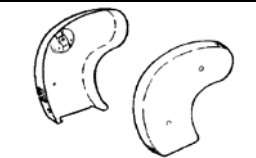
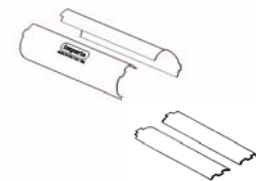
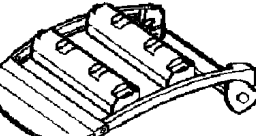
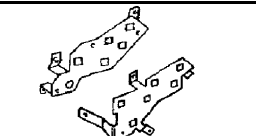
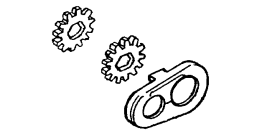
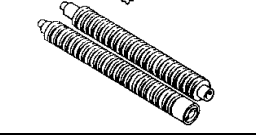
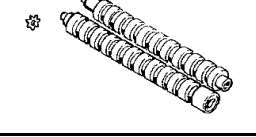
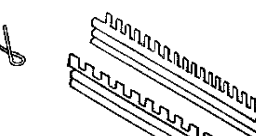
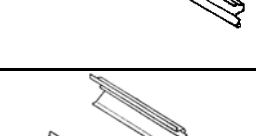
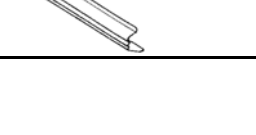
CODICE		Macchina sfogliatrice PastaPresto® 230V			
700					
DISEGNO	CODICE	DESCRIZIONE "KIT"	COMPONENTI	Q.TA'	PREZZO IN €
	KNSP-A01	KIT POMELLO	Pomello Regolatore In Plastica	1	3,00
			Molla Pomello	1	
			Leva Pomello	1	
			Tappino Trasparente Per Pomello	1	
			Prolunga Per Albero Eccentrico	1	
	KNSI-A01	KIT CUFFIE	Cuffia Destra	1	13,00
			Cuffia Sinistra	1	
	KNSI-A02	KIT GREMBIALI	Grembiale Arrotondato Centrale Con Taglio	1	3,50
			Grembiale Arrotondato Anteriore Timbrato Imperia	1	
			Grembiale Arrotondato Centrale Senza Taglio	1	
			Grembiale Arrotondato Posteriore Neutro	1	
	KNSP-A04	KIT DISPOSITIVO DI SICUREZZA	Gruppo Mobile Di Sicurezza	1	19,00
	KNSP-A06	KIT PIASTRE PORTA INGRANAGGI	Piastra Portaingranaggi Inferiore	1	3,50
			Piastra Portaingranaggi Superiore Con Rinforzo	1	
	KSSP-A08	KIT CARTERINO	Ingranaggio Rulli Lisci	2	2,50
			Carterino	1	
	KDSP-A03	KIT RULLI RIGATI TG.2	Rullo Rigato Taglio 2 Conduttore	1	4,00
			Rullo Rigato Taglio 2 Condotto	1	
			Ingranaggio Rulli Rigati	2	
	KDSP-A07	KIT RULLI RIGATI TG.4	Rullo Rigato Taglio 4 Conduttore	1	4,00
			Rullo Rigato Taglio 4 Condotto	1	
			Ingranaggio Rulli Rigati	2	
	KDSP-A04	KIT RASCHIATORI TG.2	Molla Ritegno Raschiatori	2	2,50
			Raschiatore Taglio 2 In Resina Acetalica	2	
	KDSP-A08	KIT RASCHIATORI TG.4	Molla Ritegno Raschiatori	2	2,50
			Raschiatore Taglio 4 In Resina Acetalica	2	
	KSSI-A05	KIT RASCHIATORI	Raschiatore Liscio Fisso In Resina Acetalica	3	2,00
			Raschiatore Liscio Oscill. In Resina Acetalica	3	

CODICE		Macchina sfogliatrice PastaPresto® 230V			
700					
DISEGNO	CODICE	DESCRIZIONE "KIT"	COMPONENTI	Q.TA'	PREZZO IN €
	<b>KSSP-A09</b>	KIT RULLI LISCI	Asta Soppoorto Raschiatore	2	<b>5,50</b>
			Asse Eccentrico	1	
			Rullo Liscio Fisso	1	
			Rullo Liscio Oscillante	1	
			Rondella Di Rasamento	2	
			Raschiatore Liscio Fisso In Resina Acetalica	1	
			Raschiatore Liscio Oscill. In Resina Acetalica	1	
	<b>KNSP-A07</b>	KIT RIDUTTORE	Riduttore Con Albero Lento	1	<b>23,50</b>
	<b>KNSP-A08</b>	KIT SCIVOLATOIO	Scivolatoio Timbrato Imperia	1	<b>5,00</b>
	<b>KNSP-A09</b>	KIT BASE	Piastra Base	1	<b>13,50</b>
	<b>KNSP-A10</b>	KIT PIEDINI	Soppoorto Piedino	2	<b>8,50</b>
			Fondo Base	1	
			Piedino In Gomma Forato	4	
	<b>KNSP-A11</b>	KIT MOTORE	Motore 230V 50Hz Rotazione Antioraria	1	<b>26,50</b>
	<b>KNSI-A03</b>	KIT COMPONENTI ELETTRICI INTERRUTTORE BLU 2 POSIZ LUMINOSO	Interruttore Blu Luminoso	1	<b>12,00</b>
			Condensatore 0,047µf	1	
			Cavetto Azzurro 0,75 X 250	2	
			Morsettiera 4 Vie Neutra	1	
			Microinterruttore A Leva	1	
			Cavetto Blu 0,75 X 300	1	
			Gruppo Cavetto Senza Diodo	1	
			Sottomorsettiera	1	
			Cavetto Giallo/Verde Pvc 0,75 X 120	1	
Distanziale Microinterruttore	1				
	<b>KRMN-A05</b>	KIT ALIMENTAZIONE	Cavo Alimentazione Spina Schuko	1	<b>4,50</b>
			Pressacavo	1	
	<b>KNSP-A14</b>	KIT INGRANAGGI	Ingranaggio Albero Riduttore Z=24 M=1,5	1	<b>6,50</b>
			Ingranaggio Trascinamento Rulli E Rinvio	4	
			Ingranaggio Di Rinvio Z=32 M=1,5	1	
	<b>KNSP-A15</b>	KIT PERNI	Perno Ingranaggio Di Rinvio Z=32	1	<b>4,50</b>
			Perno Trascinamento Rulli	3	
			Perno Ingranaggio Di Rinvio Z=20	1	
			Boccola Albero Di Trascinamento	11	
			Spina Ø3 X 16	5	
	<b>KXR-A16</b>	KIT MANOVELLA	Manovella Con Tappino Cromato	1	<b>3,50</b>

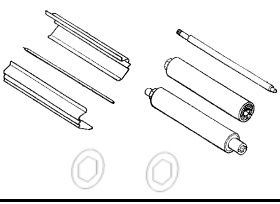
CODICE		Macchina sfogliatrice PastaPresto® 230V			
700					
DISEGNO	CODICE	DESCRIZIONE "KIT"	COMPONENTI	Q.TA'	PREZZO IN €
	KNSP-A17	KIT FLANGIA	Flangia Distanziale Motore	1	2,50
	KNSP-A18	KIT STAFFA	Staffa Sopperto Micro	1	3,00
	KNSP-A19	KIT TIRANTI / TUBETTI	Tirante 5,25 X 157 Tirante 4MA X 157 Tubetto Distanziale	4 1 2	2,50
	KNSP-E01	KIT VARIE / MINUTERIE	Camma Azionamento Microinterruttore Piedino In Gomma Forato Gommino In Gomma Antivibrante Boccola Piccola Boccola Grande Boccola Eccentrica Registrazione Rulli	1 4 1 2 2 1	3,50

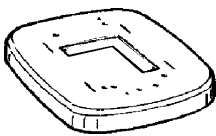
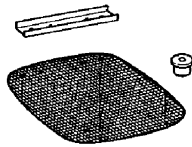
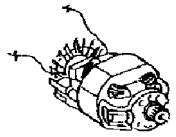
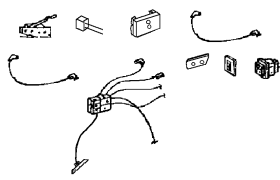



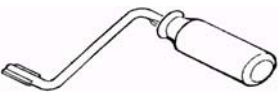

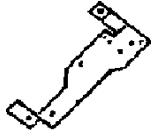

CODICE		Macchina sfogliatrice PastaPresto® 120V			
720					
DISEGNO	CODICE	DESCRIZIONE "KIT"	COMPONENTI	Q.TA'	PREZZO IN €
	KNSP-A01	KIT POMELLO	Pomello Regolatore	1	3,00
			Molla Pomello	1	
			Leva Pomello	1	
			Tappino Trasparente Per Pomello	1	
			Prolunga Albero Eccentrico	1	
	KNSI-A01	KIT CUFFIE	Cuffia Destra	1	13,00
			Cuffia Sinistra	1	
	KNSI-A02	KIT GREMBIALI	Grembiale Arrotondato Centrale Con Taglio	1	3,50
			Grembiale Arrotondato Anteriore Neutro	1	
			Grembiale Arrotondato Centrale Senza Taglio	1	
			Grembiale Arrotondato Posteriore Neutro	1	
	KNSP-A04	KIT DISPOSITIVO DI SICUREZZA	Gruppo Mobile Di Sicurezza	1	19,00
	KNSP-A06	KIT PIASTRE PORTA INGRANAGGI	Piastra Porta Ingranaggi Inferiore	1	3,50
			Piastra Porta Ingranaggi Superiore Con Rinforzo	1	
	KSSP-A08	KIT CARTERINO	Ingranaggio Rulli Lisci	2	2,50
			Carterino	1	
	KDSP-A03	KIT RULLI RIGATI TG.2	Rullo Rigato Taglio 2 Conduttore	1	4,00
			Rullo Rigato Taglio 2 Condotto	1	
			Ingranaggio Rulli Rigati	2	
	KDSP-A07	KIT RULLI RIGATI TG.4	Rullo Rigato Taglio 4 Conduttore	1	4,00
			Rullo Rigato Taglio 4 Condotto	1	
			Ingranaggio Rulli Rigati	2	
	KDSP-A04	KIT RASCHIATORI TG.2	Molla Ritegno Raschiatori	2	2,50
			Raschiatore Taglio 2 In Resina Acetalica	2	
	KDSP-A08	KIT RASCHIATORI TG.4	Molla Ritegno Raschiatori	2	2,50
			Raschiatore Taglio 4 In Resina Acetalica	2	
	KSSI-A05	KIT RASCHIATORI	Raschiatore Liscio Fisso In Resina Acetalica	3	2,00
			Raschiatore Liscio Oscill. In Resina Acetalica	3	



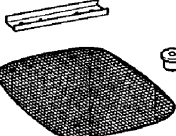

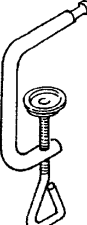



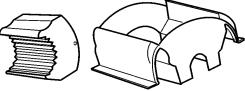
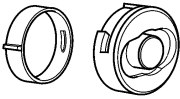
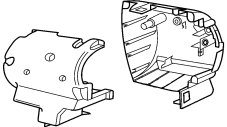
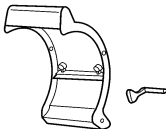
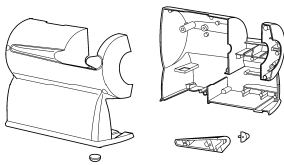
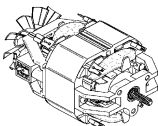
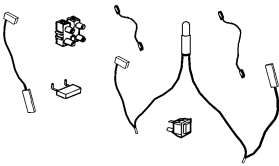

CODICE		Macchina sfogliatrice PastaPresto® 120V			
720					
DISEGNO	CODICE	DESCRIZIONE "KIT"	COMPONENTI	Q.TA'	PREZZO IN €
	<b>KSSP-A09</b>	KIT RULLI LISCI	Asta Supporto Raschiatore	2	<b>5,50</b>
			Asse Eccentrico	1	
			Rullo Liscio Fisso	1	
			Rullo Liscio Oscillante	1	
			Rondella Di Rasamento	2	
			Raschiatore Liscio Fisso In Resina Acetalica	1	
			Raschiatore Liscio Oscill. In Resina Acetalica	1	
	<b>KNSP-A07</b>	KIT RIDUTTORE	Riduttore Con Albero Lento	1	<b>23,50</b>
	<b>KNSP-A08</b>	KIT SCIVOLATOIO	Scivolatoio Timbrato Imperia	1	<b>5,00</b>
	<b>KNSP-A09</b>	KIT BASE	Piastra Base	1	<b>13,50</b>
	<b>KNSP-A10</b>	KIT PIEDINI	Sopporto Piedino	2	<b>8,50</b>
			Fondo Base	1	
			Piedino In Gomma Forato Nsp	4	
	<b>KNSP-A20</b>	KIT MOTORE 120V	Motore 117V - 60Hz Rotazione Antioraria	1	<b>28,50</b>
	<b>KNSI-A03</b>	KIT COMPONENTI ELETTRICI INTERRUTTORE BLU 2 POSIZ LUMINOSO	Cappuccio Antispruzzo Per Int.	1	<b>13,00</b>
			Interruttore B415C12190000	1	
			Condensatore 0,047µ Pasta Facile	1	
			Cavetto Verde 18Awg L=20	1	
			Morsettiera 4 Vie Neutra	1	
			Microinterruttore A Leva Rm	1	
			Cavetto Bianco 18Awg L=300	1	
			Gruppo Cavetto Con Diodo 18Awg	1	
			Sottomorsettiera Rm	1	
			Cavetto Bianco 18Awg L=200	1	
Distanziale Microinterruttore Rmn	1				
	<b>KRMN-A17</b>	KIT ALIMENTAZIONE 120V	Cavo Alimentazione Rm (U.S.A.)	1	<b>4,50</b>
			Pressacavo Rm	1	
	<b>KNSP-A14</b>	KIT INGRANAGGI	Ingranaggio Albero Riduttore Z=24 M=1,5	1	<b>6,00</b>
			Ingranaggio Trascinamento Rulli E Rinvio	4	
			Ingranaggio Di Rinvio Z=32 M=1,5	1	
	<b>KNSP-A15</b>	KIT PERNI	Perno Ingranaggio Di Rinvio Z=32	1	<b>4,50</b>
			Perno Trascinamento Rulli Nsp Finito	3	
			Perno Ingranaggio Di Rinvio Z=20	1	
			Boccola Albero Di Trascinamento	11	
			Spina Diam 3X16	5	
	<b>KXR-A16</b>	KIT MANOVELLA	Manovella	1	<b>3,50</b>

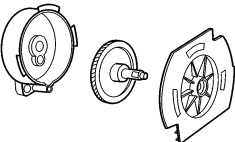
CODICE		Macchina sfogliatrice PastaPresto® 120V			
720					
DISEGNO	CODICE	DESCRIZIONE "KIT"	COMPONENTI	Q.TA'	PREZZO IN €
	<b>KNSP-A17</b>	KIT FLANGIA	Flangia Distanziale Motore	1	<b>2,50</b>
	<b>KNSP-A18</b>	KIT STAFFA	Staffa Sopperto Micro	1	<b>3,00</b>
	<b>KNSP-A19</b>	KIT TIRANTI / TUBETTI	Tirante 5,25 X 157 Finito Tirante Titania 4Ma X 157 Filett. Tubetto Distanziale	4 1 2	<b>2,50</b>
	<b>KNSP-E01</b>	KIT VARIE / MINUTERIE	Camme Azionamento Microinterruttore Piedino In Gomma Forato Gommino In Gomma Antivibrante Boccola Piccola Boccola Grande Boccola Eccentrica Registrazione Rulli	1 4 1 2 2 1	<b>3,50</b>

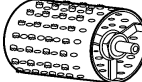
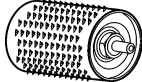
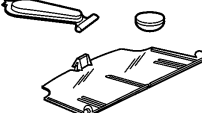
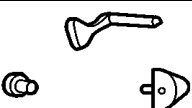
CODICE		Sfogliatrice Pasta Presto® Manuale			
740					
DISEGNO	CODICE	DESCRIZIONE "KIT"	COMPONENTI	Q.TA'	PREZZO IN €
	KNSP-A01	KIT POMELO	Pomello Regolatore	1	3,00
			Molla Pomello	1	
			Leva Pomello	1	
			Tappo Per Pomello Nsp	1	
			Prolunga Albero Eccentrico	1	
	KNSI-M-A01	KIT CUFFIE	Cuffia Destra	1	12,00
			Cuffia Sinistra	1	
	KNSI-A02	KIT GREMBIALI ARROTONDATI	Grembiale Arrotondato Centrale Con Taglio	1	3,50
			Grembiale Arrotondato Anteriore Timbrato Imperia	1	
			Grembiale Arrotondato Centrale Senza Taglio	1	
			Grembiale Arrotondato Posteriore Neutro	1	
	KNSP-M-A03	KIT PIASTRA / PERNI	Piastra Porta Perni Rotazione Rulli	1	6,00
			Perno Rotazione Rulli	3	
			Boccola Sopperto Rulli	3	
	KSSP-A08	KIT CARTERINO	Ingranaggio Rulli Lisci	2	2,50
			Carterino	1	
	KDSP-A03	KIT RULLI RIGATI TG.2	Rullo Rigato Conduttore	1	4,00
			Rullo Rigato Condotto	1	
			Ingranaggio	2	
	KDSP-A07	KIT RULLI RIGATI TG.4	Rullo Rigato Conduttore	1	4,00
			Rullo Rigato Condotto	1	
			Ingranaggio	2	
	KSSI-A05	KIT RASCHIATORI	Raschiatore Liscio Fisso In Resina Acetalica	3	2,00
			Raschiatore Liscio Oscill. In Resina Acetalica	3	
	KSSP-A09	KIT RULLI LISCI	Asta Sopperto Raschiatore	2	5,50
			Asse Eccentrico	1	
			Rullo Liscio Sp Fisso	1	
			Rullo Liscio Sp Oscillante	1	
			Rondella Di Rasamento	2	
			Raschiatore Liscio Fisso In Resina Acetalica	1	
			Raschiatore Liscio Oscill. In Resina Acetalica	1	
	KDSP-A04	KIT RASCHIATORI TG.2	Molla Ritegno Raschiatori	2	2,50
			Raschiatore Taglio 2 In Resina Acetalica	2	
	KDSP-A08	KIT RASCHIATORI TG.4	Molla Ritegno Raschiatori	2	2,50
			Raschiatore Taglio 4 In Resina Acetalica	2	

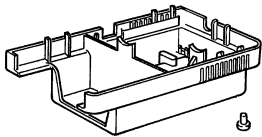
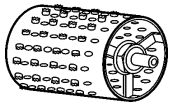
CODICE		Sfogliatrice Pasta Presto® Manuale			
740					
DISEGNO	CODICE	DESCRIZIONE "KIT"	COMPONENTI	Q.TA'	PREZZO IN €
	<b>KNSP-A08</b>	KIT SCIVOLATOIO	Scivolatoio Timbrato Imperia	1	<b>5,00</b>
	<b>KNSP-M-A04</b>	KIT BASE	Piastra Base Nsp Manuale	1	<b>14,00</b>
			Tassello Morsetto	1	
	<b>KNSP-A10</b>	KIT PIEDINI	Sopporito Piedino	2	<b>8,50</b>
			Fondo Base	1	
			Piedino In Gomma Forato	4	
	<b>KXR-A16</b>	KIT MANOVELLA	Manovella	1	<b>3,50</b>
	<b>KNSP-M-A05</b>	KIT MORSETTO	Morsetto Nsp Manuale	1	<b>3,00</b>
	<b>KNSP-A18</b>	KIT STAFFA	Staffa Sopporito Micro	1	<b>3,00</b>
	<b>KNSP-A19</b>	KIT TIRANTI / TUBETTI	Tirante 5,25 X 157 Finito	4	<b>2,50</b>
			Tirante Titania 4Ma X 157 Filett.	1	
			Tubetto Distanziale	2	
	<b>KNSP-M-E01</b>	KIT VARIE / MINUTERIE	Tassello Morsetto	1	<b>4,50</b>
			Piedino In Gomma Forato	4	
			Perno Rotazione Rulli	1	
			Boccola Sopporito Rulli Simplex	1	
			Boccola Piccola	2	
			Boccola Grande	2	
			Prolunga Albero Eccentrico	1	
			Boccola Eccentrica Registrazione Rulli	1	

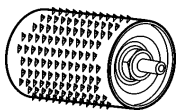
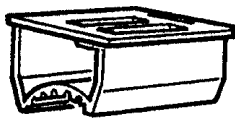
CODICE		Grattugia Presto Cheese® 230V			
800					
DISEGNO	CODICE	DESCRIZIONE "KIT"	COMPONENTI	Q.TA'	PREZZO IN €
	<b>KNGR-A01</b>	KIT TRAMOGGIA / PESTELLO	Tramoggia Plastica Pestello Plastica	1 1	<b>3,00</b>
	<b>KNGR-A02</b>	KIT MANOPOLA	Manopola Frontalino Ghiera Supporto Manopola	1 1	<b>3,00</b>
	<b>KNGR-A03</b>	KIT GUSCI	Guscio Interno Destro Guscio Interno Sinistro	1 1	<b>3,50</b>
	<b>KNGR-A04</b>	KIT COPERCHIO	Coperchio Alluminio Leva Comando Perno Pulsante	1 1	<b>9,50</b>
	<b>KNGR-A05</b>	KIT RIVESTIMENTO ESTERNO	Involucro Alluminio Destro Asta Supporto Coperchio Tassello Supporto Coperchio Involucro Alluminio Sinistro Piedino In Gomma Nero	1 1 1 1 4	<b>53,50</b>
	<b>KNGR-A07</b>	KIT MOTORE 230 VOLT	Motore D.76 H.30 230V Cl.F	1	<b>24,50</b>
	<b>KNGR-A08</b>	KIT COMPONENTI ELETTRICI	Cablaggio 2 Cavetti + Segnale Cavetto 0,75 X 120 2 Faston Cavetto 0,75 X 200 Cavetto 0,75 X 140 Pulsante 2A-V250 Pasta Facile Condensatore 0,0047 Pasta Facile Moresttiera In Nylon Pasta Facile	1 1 1 1 3 1 1	<b>4,50</b>
	<b>KNGR-A09</b>	KIT VASCHETTA	Gruppo Vaschetta Completa Coperchio Vaschetta	1 1	<b>5,00</b>
	<b>KNGR-A10</b>	KIT RIDUZIONE	Scatola Riduttore Coperchio Scatola Riduttore Ingranaggio Con Albero	1 1 1	<b>4,50</b>
	<b>KNGR-A11</b>	KIT CAVO ALIMENTAZIONE	Cavo Alimentazione 230 Volt	1	<b>3,50</b>
	<b>KGRA-A02</b>	KIT RULLO FORATO	Rullo Forato	1	<b>7,50</b>
	<b>KGRA-A04</b>	KIT RULLO STAGNATO	Rullo Stagnato	1	<b>7,50</b>
	<b>KNGR-A12</b>	KIT SPORTELLO CAVO ALIMENTAZIONE	Piedino In Gomma Nero Pulsante "Push" Sportello Cavo Alimentazione	4 1 1	<b>4,50</b>
	<b>KNGR-E01</b>	KIT VARIE / MINUTERIE	Perno Comando Micro Tassello Supporto Coperchio Leva Comando Perno Pulsante	1 1 1	<b>4,50</b>

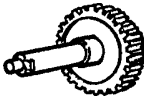
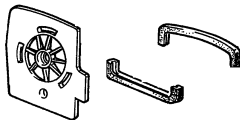
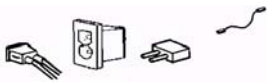
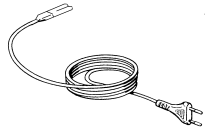
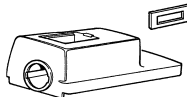
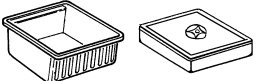
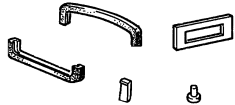
CODICE					
830 (ex GRATT2)					
DISEGNO	CODICE	DESCRIZIONE "KIT"	COMPONENTI	Q.TA'	PREZZO IN €
	KGRA-A01	KIT RIVESTIMENTO INFERIORE	Carrozza inferiore	1	4,00
			Piedino	4	
	KGRA-A02	KIT RULLO FORATO	Rullo Forato	1	7,50
	KGRA-A03	KIT FRONTALINO	Frontalino	1	2,50
			Boccola 10 X 6	1	
			Linguetta	1	
	KGRA-A04	KIT RULLO STAGNATO	Rullo Stagnato	1	7,50
	KGRA-A05	KIT PRESSINO	Pressino	1	2,50
	KGRA-A06	KIT MOTORE	Motore 230V	1	26,50
			Carcassina Motore	1	
	KGRA-A07	KIT INGRANAGGIO	Ingranaggio	1	3,00
			Inserto	1	
	KGRA-A08	KIT COPERCHIO INGRANAGGIO	Coperchio	1	2,50
			Guarnizione Isolante	2	
	KGRA-A09	KIT COMPONENTI ELETTRICI	Pulsante	1	2,50
			Filtro Antidisturbo	1	
			Connettore	1	
			Cavetto 0,75 X 150	1	
	KPF-A17	KIT ALIMENTAZIONE CON CONNETTORE	Cavo Alimentazione Con Connettore	1	3,00
	KGRA-A11	KIT RIVESTIMENTO SUPERIORE	Carrozzeria Superiore	1	5,00
			Deviatore	1	
	F..GRAC00	ACCESSORIO VASCHETTA	Vaschetta	1	3,00
			Coperchio	1	
	KGRA-E01	KIT VARIE / MINUTERIE	Deviatore	1	2,00
			Guarnizione Isolante	2	
			Linguetta	1	
			Piedino	4	

Зип Общепит  
vsezip.ru  
+7(812)987-08-81

**imperia & monferrina**

SOCIETÀ PER AZIONI

10024 Moncalieri (TO) - Italia

Partita I.V.A. e Codice Fiscale

IT 03773641000

**Kit Ricambi Release 10.00**

**[www.imperia.com](http://www.imperia.com)**

**[mauro.rinciari@imperiamonferrina.com](mailto:mauro.rinciari@imperiamonferrina.com) - tel. +39.011.93.24.308**